

TB 9-6625-2049-35

CHANGE 1

DEPARTMENT OF THE ARMY TECHNICAL BULLETIN

CALIBRATION PROCEDURE FOR SYNTHESIZER/FUNCTION GENERATOR HEWLETT-PACKARD MODELS 3325A() AND 3325B()

Headquarters, Department of the Army, Washington, DC
18 March 2002

Approved for public release; distribution is unlimited.

TB 9-6625-2049-35, 2 January 2001, is changed as follows:

1. Remove old pages and insert new pages as indicated below. New or changed material is indicated by a vertical bar in the margin of the page.

Remove Pages

1 and 2
5 and 6

Insert Pages

1 and 2
5 and 6

2. File this change sheet in front of the publication for reference purposes.

By Order of the Secretary of the Army:

ERIC K. SHINSEKI
General, United States Army
Chief of Staff

OFFICIAL:

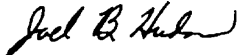

JOEL B. HUDSON
Administrative Assistant to the
Secretary of the Army

0202804

Distribution:

To be distributed in accordance with IDN 342200, requirements for calibration procedure TB 9-6625-2049-35.

***TB 9-6625-2049-35**

DEPARTMENT OF THE ARMY TECHNICAL BULLETIN

CALIBRATION PROCEDURE FOR SYNTHESIZER/FUNCTION GENERATOR HEWLETT-PACKARD

MODELS 3325A() AND 3325B()

Headquarters, Department of the Army, Washington, DC
2 January 2001

Approved for public release; distribution is unlimited

REPORTING OF ERRORS AND RECOMMENDING IMPROVEMENTS

You can help improve this publication. If you find any mistakes or if you know of a way to improve the procedure, please let us know. Mail your letter or DA Form 2028 to: Commander, U. S. Army Aviation and Missile Command, ATTN: AMSAM-MMC-MA-NP, Redstone Arsenal, AL 35898-5230. A reply will be furnished to you. You may also send in your comments electronically to our e-mail address: 2028@redstone.army.mil or by FAX (256) 842-6546/DSN 788-6546

		Paragraph	Page
SECTION	I.	IDENTIFICATION AND DESCRIPTION	
		Test instrument identification	1 2
		Forms, records, and reports	2 2
		Calibration description	3 2
	II.	EQUIPMENT REQUIREMENTS	
		Equipment required	4 4
		Accessories required.....	5 5
	III.	CALIBRATION PROCESS	
		Preliminary instructions	6 6
		Equipment setup.....	7 6
		Harmonic distortion	8 7
		Amplitude modulation distortion	9 9
		Square wave characteristics	10 10
		Ramp retrace	11 10
		Frequency accuracy.....	12 11
		Phase increment	13 13
		Sine wave amplitude and flatness	14 14
		Square wave amplitude and flatness	15 16

*This bulletin supersedes TB 9-6625-2049-35, 15 January 1996.

SECTION		Paragraph	Page
III.	CALIBRATION PROCESS - Continued		
	Triangle and ramp amplitude	16	17
	Dc offset.....	17	18
	Dc offset with ac.....	18	19
	High voltage output option 002 only.....	19	20
	Power supply.....	20	21
	Final procedure	21	22

**SECTION I
IDENTIFICATION AND DESCRIPTION**

1. Test Instrument Identification. This bulletin provides instructions for the calibration of Synthesizer/Function Generator, Hewlett-Packard, Models 3325A() and 3325B(). The manufacturer's manuals and TM 11-6625-3065-14 were used as the prime data sources in compiling these instructions. The equipment being calibrated will be referred to as the TI (test instrument) throughout this bulletin.

a. Model Variations. Option 001: High Stability Frequency Reference; Option 002: High Voltage Output; Option E04: includes Options 001, 002, and instrument front handles and chassis slides; Option 907: Front Handle Assembly; Option 908: Rack Mount Flange Kit; Option 909: Rack Mount Flange Kit/Front Handle Assembly; Option 910: Additional Operating and Service Manual. Variations among models are described in text, tables, and figures.

b. Time and Technique. The time required for this calibration is approximately 4 hours, using the dc and low frequency technique.

2. Forms, Records, and Reports

a. Forms, records and reports required for calibration personnel at all levels are prescribed by TB 750-25.

b. Adjustments to be reported are designated (R) at the end of the sentence in which they appear. When adjustments are in tables, the (R) follows the designated adjustment. Report only those adjustments made and designated with (R).

3. Calibration Description. TI parameters and performance specifications which pertain to this calibration are in table 1.

Table 1. Calibration Description

Test instrument parameters	Performance specifications	
Harmonic distortion ¹ (relative to fundamental at full output)	Fundamental frequency: 0.1 Hz To 50 kHz Accuracy: No harmonic greater than -65 dB Fundamental frequency: 50 to 200 kHz Accuracy: No harmonic greater than -60 dB Fundamental frequency: 200 kHz to 2 MHz (200 kHz to 1 MHz for option 002) Accuracy: No harmonic greater than -40 dB Fundamental frequency: 2 to 15 MHz Accuracy: No harmonic greater than -30 dB Fundamental frequency: 15 to 20 MHz Accuracy: No harmonic greater than -25 dB	
Amplitude modulation	AM distortion: ≤-30 dB at 80% modulation, 10 kHz, and 0 V dc offset	
Square wave	Rise time and fall time: ≤20 ns, (≤125 ns for option 002) at full output Symmetry: ≤.02% of period +3 ns Overshoot: ≤5% of p-p amplitude at full output (<10% of peak amplitude for option 002)	
Ramp retrace	≤3 μs retrace time, positive or negative ramps	
Frequency	Accuracy: 5 x 10 ⁻⁶ of selected value	
Sine wave	Range: 1 μHz to 20 999 999.999 Hz (option 002: .02 Hz to 25.6 kHz)	
Square wave	Range: 1 μHz to 10 999 999.999 Hz (option 002: .02 Hz to 25.6 kHz)	
Triangle	Range: 1 μHz to 10 999 999.999 Hz (option 002: .02 Hz to 10 kHz)	
Positive slope ramp	Range: 1 μHz to 10 999 999.999 Hz (option 002: .02 Hz to 10 kHz)	
Negative slope ramp	Range: 1 μHz to 10 999 999.999 Hz (option 002: .02 Hz to 10 kHz)	
Phase offset	Range: Variable ±719.9° with respect to arbitrary starting phase, or assigned zero phase Accuracy: ±0.2°	
Amplitude		Tolerance relative to programmed amplitude
Amplitude accuracy with no attenuation (attenuator range 1) into 50Ω load (no dc offset)	Sine wave: .001 Hz to 100 kHz ²	±0.1 dB
	Square wave: .001 Hz to 100 kHz	±1.0%
	Triangle: .001 Hz to 2 kHz 2 kHz to 10 kHz	±1.5% ±5%
	Ramps: .001 Hz to 500 Hz 500 Hz to 10 kHz	±1.5% ±10%
Flatness with no attenuation (attenuator range 1) into a 50Ω load		Tolerance relative to programmed amplitude at 1 kHz
	Sine wave: 100 kHz to 20 MHz	±0.3 dB
	Square wave: 100 kHz to 10 MHz	±10%

See footnotes at end of table.

Table 1. Calibration Description - Continued

Test instrument parameters	Performance specifications	
Amplitude accuracy with dc offset and no attenuation (range 1) into 50Ω load		Tolerance relative to programmed amplitude
	Sine wave: .001 Hz to 100 kHz	±0.3 dB
	Square: .001 Hz to 100 kHz	±3%
	Triangle: .001 Hz to 2 kHz 2 kHz to 10 kHz	±4% ±6%
	Ramps: .001 Hz to 500 Hz 500 Hz to 10 kHz	±4% ±11%
Attenuator accuracy (these errors are additive with the amplitude accuracy errors)	Function and frequency range	Tolerance relative to programmed amplitude
	.001 Hz to 100 kHz Attenuator ranges 2 through 8	±0.1 dB
	100 kHz to 10 MHz Attenuator ranges 2 through 8	±0.2 dB
	10 MHz to 20 MHz Attenuator ranges 2 through 4 Attenuator ranges 5 through 8	0.2 dB ±0.5 dB
Amplitude output Amplitude (option 002) (high voltage output)	Range: 1.000 mV to 10.00 V p-p Range: 4 mV to 40 V p-p (≥500Ω) Accuracy: ±2% of full output for each range at 2 kHz Flatness: ±10% of programmed amplitude	
Dc offset	Range: ±5 V dc Accuracy: ±0.4% of full peak output for each attenuator range ²	
Dc offset (option 002)	Range: ±20 V dc Accuracy: ± (1% +25 mV) of full output for each attenuator range	
Dc plus ac	Range: <1 MHz Accuracy: ±1.2% Ramps: ±2.4% Range: >1 MHz Accuracy: ±3%	

¹Not verified below 50 Hz.

²Except lowest attenuator range where accuracy is ±20 μV.

SECTION II EQUIPMENT REQUIREMENTS

4. Equipment Required. Table 2. identifies the specific equipment to be used in this calibration procedure. This equipment is issued with Secondary Transfer Calibration Standards Set AN/GSM-287. Alternate items may be used by the calibrating activity. The item selected must be verified to perform satisfactorily prior to use and must bear evidence of current calibration. The equipment must meet or exceed the minimum use specifications listed in table 2. The accuracies listed in table 2 provide a four-to-one ratio between the standard and TI.

5. Accessories Required. The accessories required for this calibration are common usage accessories, issued as indicated in paragraph 4 above, and are not listed in this calibration procedure. The following peculiar accessory is also required for this calibration: 50Ω feedthrough termination, Hewlett-Packard, Model 11048C.

Table 2. Minimum Specifications of Equipment Required

Common name	Minimum use specifications	Manufacturer and model (part number)
AUDIO ANALYZER	Output: 4.5 V, 10 kHz AM distortion: ≤-30 dB at 10 kHz Distortion: ≤-60 dB at 50 Hz	Boonton, Model 1120-S/10 (MIS-35954/2)
FREQUENCY COUNTER	Range: 99,9950 μs to 60,000,300 Hz Accuracy: 1.25 x 10 ⁻⁸ Capability: Time interval A to B	Hewlett-Packard, Model 5345A (MIS-28754/1 Type 1)
MEASURING RECEIVER	Frequency: 100 kHz to 10 MHz Volts: .683 to .732 V rms Accuracy: ±0.85% AM: 0 to 80%	Consisting of: Measuring receiver Hewlett-Packard, Model 8902A and Sensor module Hewlett- Packard, Model 11722A
MULTIMETER	Range: -20.225 to +20.225 V dc Accuracy: ±0.05% Range: 0.3416 to 20.4 V ac 100 Hz to 100 kHz Accuracy: ±0.3%	Hewlett-Packard, Model 3458A
OSCILLOSCOPE	Frequency: 1 kHz to 10 MHz Amplitude: 1.8 to 2.2 V p-p Accuracy: ±2.5% Capabilities Duty cycle: 49.7 to 50.3% Overshoot: 5% Rise time and fall time: <20 ns	Tektronix, Type 2430A (OS-291/G)
SPECTRUM ANALYZER	Frequency: 50 kHz to 20 MHz Input: -20 dBm and 40 V Display capability: <-65 dBc	(AN/USM-489A(V)1)
SYNTHESIZER/LEVEL GENERATOR	Frequency: 0.1 MHz Amplitude: 13 dBm	Hewlett-Packard, Model 3335AOPT 001-K06 (MIS-35938)
TIME FREQUENCY WORKSTATION	Reference output frequency: 10 MHz Accuracy: ±5 x 10 ⁻⁸	Autek Systems Corporation, Model 620 (MIS-38946)
RESISTANCE STANDARD	Range: 470Ω	Biddle Gray, Model 71-631 (7910328)

**SECTION III
CALIBRATION PROCESS**

6. Preliminary Instructions

a. The instructions outlined in paragraphs **6** and **7** are preparatory to the calibration process. Personnel should become familiar with the entire bulletin before beginning the calibration.

b. Items of equipment used in this procedure are referenced within the text by common name as listed in table 2.

c. Unless otherwise specified, verify the result of each test and, whenever the test requirement is not met, take corrective action before continuing with the calibration. Adjustments required to calibrate the TI are included in this procedure. Additional maintenance information is contained in TM 11-6625-3065-14 and the manufacturer's manual for this TI.

d. When indications specified in paragraphs **8** through **19** are not within tolerance, perform the power supply check prior to making adjustments. After adjustments are made, repeat paragraphs **8** through **19**. Do not perform power supply check if all other parameters are within tolerance.

e. Unless otherwise specified, all controls and control settings refer to the TI.

7. Equipment Setup

WARNING

HIGH VOLTAGE is used or exposed during the performance of this calibration. DEATH ON CONTACT may result if personnel fail to observe safety precautions. REDUCE OUTPUT(S) to minimum after each step within the performance check where applicable.

CAUTION

Before connecting TI to power source, make sure TI is set to the power source line voltage shown on rear of TI.

a. Connect TI to a 115 V ac source. Press **POWER** pushbutton to **ON** and allow at least 20 minutes for warmup.

b. Before continuing, review (1) through (4) below:

(1) The **SWEEP LINEAR/LOG, ENTRY, FUNCTION, SIGNAL**, and blue keys each have an indicator denoting that it is activated.

(2) When power is applied to the TI, some keys will be lit.

(3) Pressing any **FUNCTION** key that is active will delete that function and no ac signal will be present at the output.

(4) Some instructions will be repeated during programming. This is done to ensure correct output is available.

8. Harmonic Distortion

a. Performance Check

(1) Connect TI **EXT REF IN 1, 10 MHz** to spectrum analyzer **10 MHz REF IN/OUT**.

(2) Connect TI **SIGNAL** to spectrum analyzer **INPUT 50W**.

(3) Press keys and enter values using **DATA** keys as listed in (a) through (h) below:

(a) **SIGNAL** off (option 002 not lit).

(b) **FUNCTION** sine wave.

(c) **ENTRY AMPTD**.

(d) **-20 dBm**.

(e) **ENTRY DC OFFSET**.

(f) **0 VOLT**.

(g) **ENTRY FREQ**.

(h) **20 MHz**.

(4) Adjust spectrum analyzer controls to display 20 MHz fundamental and at least four harmonics. All harmonics will be at least 25 dB below fundamental.

(5) Enter **14 MHz** using TI **DATA** keys. Adjust spectrum analyzer controls to display 14 MHz fundamental and at least four harmonics. All harmonics will be at least 30 dB below fundamental.

(6) Enter **1.9 MHz** using TI **DATA** keys. Adjust spectrum analyzer controls to display 1.9 MHz fundamental and at least four harmonics. All harmonics will be at least 40 dB below fundamental.

(7) Enter **190 kHz** using TI **DATA** keys. Adjust spectrum analyzer controls to display 190 kHz fundamental and at least four harmonics. All harmonics will be at least 60 dB below fundamental.

(8) Enter **100 kHz** using TI **DATA** keys. Adjust spectrum analyzer controls to display 100 kHz fundamental and at least four harmonics. All harmonics will be at least 60 dB below fundamental.

(9) Enter **40 kHz** using TI **DATA** keys. Adjust spectrum analyzer controls to display 40 kHz fundamental and at least four harmonics. All harmonics will be at least 65 dB below fundamental.

(10) Disconnect TI from spectrum analyzer.

(11) Connect TI **SIGNAL** to audio analyzer **INPUT HIGH** using 50Ω feedthrough termination.

(12) Press keys and enter values using **DATA** keys as listed in (a) through (c) below:

TB 9-6625-2049-35

- (a) **50 Hz.**
- (b) **ENTRY AMPTD.**
- (c) **10 VOLT.**

(13) Set audio analyzer to measure distortion in dB. Audio analyzer indication will be ≤ -65 dB.

(14) Perform (15) through (19) below for option 002 only.

(15) Connect equipment as shown in figure 1 and set resistance standard to 470 Ω .

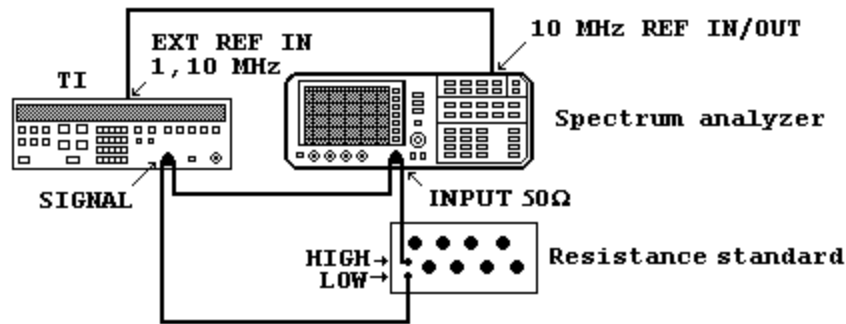

Figure 1. Harmonic distortion - equipment setup.

(16) Press keys and enter values using **DATA** keys as listed in (a) through (e) below:

- (a) **SIGNAL** on.
- (b) **ENTRY FREQ.**
- (c) **25 kHz.**
- (d) **ENTRY AMPTD.**
- (e) **40 VOLT.**

(17) Adjust spectrum analyzer controls to display 25 kHz fundamental and at least four harmonics. All harmonics will be at least 65 dB below fundamental.

(18) Press **ENTRY FREQ** key and enter **190 kHz** using **DATA** keys. Adjust spectrum analyzer controls to display 190 kHz fundamental and at least four harmonics. All harmonics will be at least 60 dB below fundamental.

(19) Enter **1 MHz** using **DATA** keys. Adjust spectrum analyzer controls to display 1 MHz fundamental and at least four harmonics. All harmonics will be at least 40 dB below fundamental.

b. Adjustment. No adjustments can be made.

9. Amplitude Modulation Distortion

a. Performance Check

(1) Press keys and enter values using **DATA** keys as listed in (a) through (i) below:

- (a) **SIGNAL** off (option 002 not lit).
- (b) **FUNCTION** sine wave.
- (c) **ENTRY FREQ.**
- (d) **1 MHz.**
- (e) **ENTRY AMPTD.**
- (f) **3 VOLT.**
- (g) **ENTRY DC OFFSET.**
- (h) **0 VOLT.**
- (i) Blue then **AM ON.**

(2) Connect equipment as shown in figure 2.

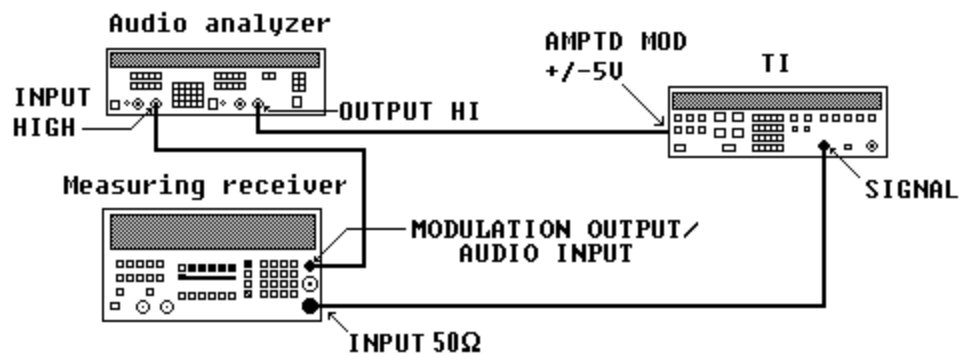

Figure 2. AM distortion - equipment setup.

- (3) Set audio analyzer for a 50Ω (SPCL 75), 10 kHz, 2.5 V output.
- (4) Set measuring receiver to measure AM.
- (5) Adjust audio analyzer level until measuring receiver indicates 80%.
- (6) Set audio analyzer to measure distortion in dB. Audio analyzer indication will be ≤ -30 dB.
- (7) Press TI blue key then **DATA AM OFF** key.

b. Adjustments. No adjustments can be made.

10. Square Wave Characteristics

a. Performance Check

(1) Press keys and enter values using **DATA** keys as listed in (a) through (f) below:

- (a) **SIGNAL** off (option 002 not lit).
- (b) **FUNCTION** square wave.
- (c) **ENTRY FREQ.**
- (d) **1 MHz.**
- (e) **ENTRY AMPTD.**
- (f) **1 V RMS.**

(2) Connect TI **SIGNAL** to oscilloscope **CH 1**.

(3) Set oscilloscope **CH 1 COUPLING 50W** to **ON**.

(4) Set oscilloscope controls for duty cycle measurement. Duty cycle will be between 49.7 and 50.3 percent.

(5) Enter **10 VOLT** using **DATA** keys.

(6) Set oscilloscope controls for rise time measurement. Rise time will be ≤ 20 ns.

(7) Repeat (6) above for fall time.

(8) Set oscilloscope controls for overshoot measurement. Overshoot will be ≤ 5 percent of peak to peak amplitude (≤ 500 mV at positive and negative peaks).

(9) Perform (10) through (12) below for option 002 only.

(10) Set oscilloscope **CH 1 COUPLING 50W** to **OFF**.

(11) Press TI **SIGNAL** key on (lit).

(12) Repeat technique in (6) through (8) above. Rise time and fall time will be ≤ 125 ns with an overshoot < 10 percent of peak amplitude (< 500 mV at positive and negative peaks).

b. Adjustments. No adjustments can be made.

11. Ramp Retrace

a. Performance Check

(1) Connect TI **SIGNAL** to oscilloscope **CH 1**.

(2) Set oscilloscope **CH 1 COUPLING 50W** to **ON**.

(3) Press keys and enter values using **DATA** keys as listed in (a) through (f) below:

- (a) **SIGNAL** off (option 002 not lit).
- (b) **FUNCTION** positive ramp.

- (c) **ENTRY FREQ.**
- (d) **10 kHz.**
- (e) **ENTRY AMPTD.**
- (f) **10 VOLT.**

(4) Set oscilloscope controls to measure ramp retrace time from the 90 to 10 percent points. Ramp retrace time will be $\leq 3 \mu\text{s}$.

(5) Press **FUNCTION** negative ramp key and repeat (4) above.

b. Adjustments. No adjustments can be made.

12. Frequency Accuracy

a. Performance Check

(1) Connect TI **SIGNAL** to frequency counter **CHANNEL A**.
 (2) Press keys and enter values using **DATA** keys as listed in (a) through (f) below:

- (a) **SIGNAL** off (option 002 not lit).
- (b) **FUNCTION** sine wave.
- (c) **ENTRY FREQ.**
- (d) **20 MHz.**
- (e) **ENTRY AMPTD.**
- (f) **.99 VOLT.**

(3) Set frequency counter **50W/1MW** switch to **50W**.

(4) Set frequency counter controls to measure frequency. If frequency counter does not indicate between 19.99990 and 20.00010 MHz, perform **b** below.

(5) Press **FUNCTION** square wave key. Frequency counter will indicate between 9.999950 and 10.000050 MHz.

(6) Disconnect frequency counter from TI **SIGNAL**.

(7) Connect frequency counter **CHANNEL A** to TI **SYNC OUT**.

(8) Press TI **FUNCTION** triangle key.

(9) Set frequency counter controls to measure period. Frequency counter will indicate between 99.99950 and 100.00050 μs .

(10) Press **FUNCTION** positive ramp key. Frequency counter will indicate between 99.99950 and 100.00050 μs .

(11) Press **FUNCTION** negative ramp key. Frequency counter will indicate between 99.99950 and 100.00050 μs .

(12) Disconnect frequency counter from TI **SYNC OUT**.

TB 9-6625-2049-35

- (13) Connect frequency counter to TI **AUX 21-60 MHz** (rear panel).
- (14) Press keys and enter values using **DATA** keys as listed in (a) through (c) below:
 - (a) **FUNCTION** sine wave.
 - (b) **ENTRY FREQ.**
 - (c) **60 MHz.**
- (15) Set frequency counter controls to measure frequency. If frequency counter does not indicate between 59.99970 and 60.00030 MHz, perform **b** below.

b. Adjustments

- (1) Disconnect TI rear panel **10 MHz OVEN OUTPUT** from **EXT REF IN** option 001 only.
- (2) Connect frequency counter **CHANNEL A** to TI rear panel **AUX 21-60 MHz**.
- (3) Press keys and enter values using **DATA** keys as listed in (a) through (c) below:
 - (a) **FUNCTION** sine wave.
 - (b) **ENTRY FREQ.**
 - (c) **60 MHz.**
- (4) Adjust REF R30 (fig. 3) until frequency counter indicates 60.000000 MHz (R).

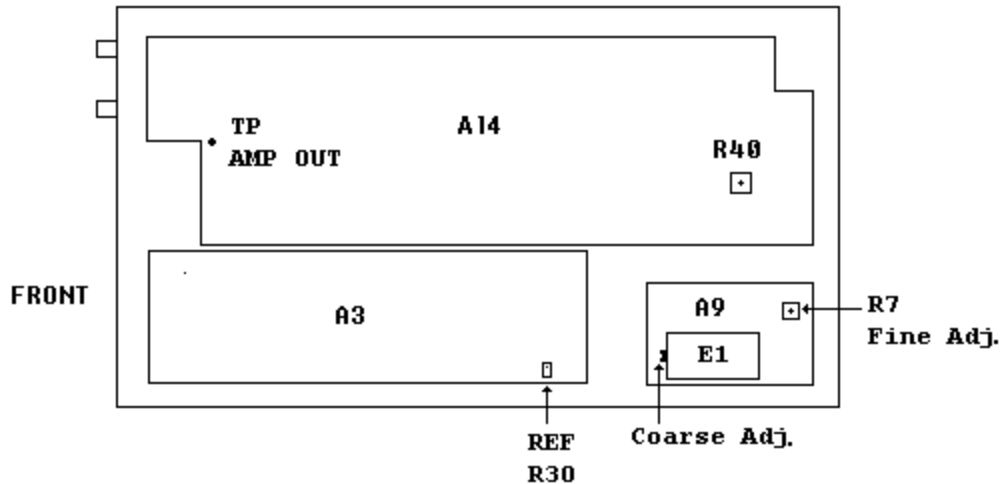

Figure 3. Test instrument - bottom view.

- (5) Disconnect frequency counter from TI rear panel **AUX 21-60 MHz**.
- (6) Connect frequency counter **CHANNEL A** to TI **SIGNAL**.
- (7) Enter **20 MHz** using **DATA** keys. Frequency counter will indicate between 19.99990 and 20.00010 MHz.

- (8) Disconnect frequency counter from TI.
- (9) Perform (10) through (14) below for option 001 only.
- (10) Connect time/frequency workstation **OUTPUT 1 MHz** to frequency difference meter **REF INPUT**.
- (11) Connect TI rear panel **10 MHz OVEN OUTPUT** to frequency difference meter **SIG INPUT**.
- (12) Adjust A9R7 Fine Adj. (fig. 3) and A9 Coarse Adj. (fig. 3) for a minimum indication on frequency difference meter.
- (13) Disconnect TI from frequency difference meter.
- (14) Reconnect TI rear panel **10 MHz OVEN OUTPUT** to **EXT REF IN**.

13. Phase Increment

a. Performance Check

- (1) Press keys and enter values using **DATA** keys as listed in (a) through (f) below:
 - (a) **SIGNAL** off (option 002 not lit).
 - (b) **FUNCTION** sine wave.
 - (c) **ENTRY FREQ.**
 - (d) **100 kHz.**
 - (e) **ENTRY AMPTD.**
 - (f) **13 dBm.**
- (2) Connect equipment as shown in figure 4.

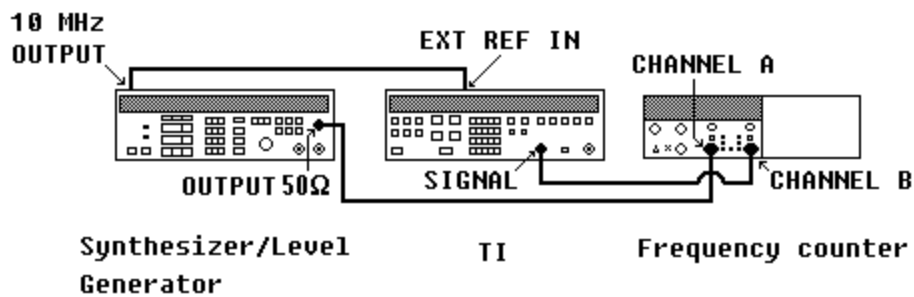

Figure 4. Phase increment - equipment setup.

NOTE

If TI has option 001, remove the connection from **10 MHz OUTPUT** to **EXT REF IN** (rear panel) (fig. 4).

- (3) Set synthesizer/level generator frequency to .1 MHz and amplitude to 13 dBm.

TB 9-6625-2049-35

- (4) Set frequency counter controls for time interval A to B measurement.
- (5) Press keys as listed in (a) through (c) below:
 - (a) **ENTRY PHASE**.
 - (b) **MODIFY** until frequency counter indicates between 199 and 201 ns.
 - (c) Blue then **ASGN ZERO PHASE**.
- (6) Adjust frequency counter sample rate control to **HOLD** and press **RESET** pushbutton. Record frequency counter indication.
- (7) Press **ENTRY PHASE** key and enter **-1 deg** using **DATA** keys.
- (8) Press frequency counter **RESET** pushbutton and record frequency counter indication.
- (9) Determine the difference between indication recorded in (6) above and indication recorded in (8) above. The difference will be between 22.22 and 33.34 ns.
- (10) Enter **-10 deg** using **DATA** keys.
- (11) Press frequency counter **RESET** pushbutton and record frequency counter indication.
- (12) Determine the difference between indication recorded in (6) above and indication recorded in (11) above. The difference will be between 272.22 and 283.34 ns.
- (13) Enter **-100 deg** using **DATA** keys.
- (14) Press frequency counter **RESET** pushbutton and record frequency counter indication.
- (15) Determine the difference between indication recorded in (6) above and indication recorded in (14) above. The difference will be between 2722.22 and 2783.34 ns.

b. Adjustments. No adjustments can be made.

14. Sine wave Amplitude and Flatness

a. Performance Check

- (1) Connect TI **SIGNAL** to multimeter **INPUT HI** and **LO** using 50 Ω feedthrough termination.
- (2) Press keys and enter values using **DATA** keys as listed in (a) through (i) below:
 - (a) **SIGNAL** off (option 002 not lit).
 - (b) **ENTRY DC OFFSET**.
 - (c) **0 VOLT**.
 - (d) **FUNCTION** sine wave.
 - (e) **ENTRY AMPTD**.
 - (f) **3.536 V RMS**.

- (g) **ENTRY FREQ.**
- (h) **100 Hz.**
- (i) **AMPTD CAL.**

(3) Multimeter will indicate between 3.495 and 3.577 V ac.

(4) Repeat technique of (2)(e) through (i) and (3) above using TI settings and multimeter indications listed in table 3.

Table 3. Amplitude

Test instrument settings			Multimeter indications	
ENTRY AMPTD		ENTRY FREQ	(V ac)	
3.536	V RMS	1 kHz	3.495	3.577
3.536	V RMS	100 kHz	3.495	3.577
1.061	V RMS	100 kHz	1.048	1.073
1.061	V RMS	1 kHz	1.048	1.073
1.061	V RMS	100 Hz	1.048	1.073
.3536	V RMS ¹	100 Hz	0.3416	0.3660
.3536	V RMS	1 kHz	0.3416	0.3660
.3536	V RMS	100 kHz	0.3416	0.3660

¹Press **ENTRY DC OFFSET** key and enter **1 mV** using **DATA** keys.

(5) Press keys and enter values using **DATA** keys as listed in (a) through (g) below:

- (a) **ENTRY DC OFFSET.**
- (b) **0 mV.**
- (c) **ENTRY FREQ.**
- (d) **1 kHz.**
- (e) **ENTRY AMPTD.**
- (f) **.707 V RMS.**
- (g) **AMPTD CAL.**

(6) Press **MODIFY** keys for a multimeter indication as close as possible to 0.707 V ac.

(7) Enter **100 kHz** using **DATA** keys. Multimeter will indicate between 0.683 and 0.732 V ac. Record multimeter indication.

(8) Disconnect multimeter and 50Ω feedthrough termination from TI.

NOTE

If necessary, ZERO and CALIBRATE measuring receiver and sensor module.

- (9) Connect measuring receiver sensor module to TI **SIGNAL**.
- (10) Set measuring receiver to measure volts at .1 MHz.
- (11) Press **ENTRY AMPTD** key.

TB 9-6625-2049-35

(12) Press **MODIFY** keys for a measuring receiver indication as close as possible to indication recorded in (7) above.

(13) Press **ENTRY FREQ** key and enter **500 kHz** using **DATA** keys.

(14) Set measuring receiver to measure volts at .5 MHz. Measuring receiver will indicate between 0.683 and 0.732 V.

(15) Repeat technique of (13) and (14) above using TI and measuring receiver settings listed in table 4. Measuring receiver will indicate between 0.683 and 0.732 V.

Table 4. Flatness

Test instrument and measuring receiver settings (MHz)
1
2
4
6
8
10
12
14
16
18
20

b. Adjustments. No adjustments can be made.

15. Square Wave Amplitude and Flatness

a. Performance Check

(1) Connect TI **SIGNAL** to multimeter **INPUT HI** and **LO** using 50Ω feedthrough termination.

(2) Press keys and enter values using **DATA** keys as listed in (a) through (i) below:

- (a) **SIGNAL** off (option 002 not lit).
- (b) **ENTRY DC OFFSET**.
- (c) **0 VOLT**.
- (d) **FUNCTION** square wave.
- (e) **ENTRY AMPTD**.
- (f) **5 V RMS**.
- (g) **ENTRY FREQ**.
- (h) **100 Hz**.
- (i) **AMPTD CAL**.

- (3) Multimeter will indicate between 4.95 and 5.05 V ac.
- (4) Enter **1 kHz** using **DATA** keys. Multimeter will indicate between 4.95 and 5.05 V ac.
- (5) Enter **100 kHz** using **DATA** keys. Multimeter will indicate between 4.95 and 5.05 V ac.
- (6) Press keys and enter values using **DATA** keys as listed in (a) through (d) below:
 - (a) **1 kHz.**
 - (b) **ENTRY AMPTD.**
 - (c) **1 V RMS.**
 - (d) **AMPTD CAL.**
- (7) Multimeter will indicate between 0.99 and 1.01 V ac.
- (8) Disconnect TI from multimeter.
- (9) Connect TI **SIGNAL** to oscilloscope **CH 1** using 50 Ω feedthrough termination.
- (10) Set oscilloscope controls to measure square wave amplitude. Record oscilloscope indication.
- (11) Press **ENTRY FREQ** key and enter **1 MHz** using **DATA** keys.
- (12) Set oscilloscope controls to measure square wave amplitude. Oscilloscope indication will be within ± 10 percent of indication recorded in (10) above.
- (13) Enter **3 MHz** using **DATA** keys and repeat (12) above.
- (14) Enter **5 MHz** using **DATA** keys and repeat (12) above.
- (15) Enter **10 MHz** using **DATA** keys and repeat (12) above.

b. Adjustments. No adjustments can be made.

16. Triangle and Ramp Amplitude

a. Performance Check

- (1) Connect TI **SIGNAL** to multimeter **INPUT HI** and **LO** using 50 Ω feedthrough termination.
- (2) Press keys and enter values using **DATA** keys as listed in (a) through (i) below:
 - (a) **SIGNAL** off (option 002 not lit).
 - (b) **ENTRY DC OFFSET.**
 - (c) **0 VOLT.**
 - (d) **FUNCTION** triangle.
 - (e) **ENTRY AMPTD.**
 - (f) **2.887 V RMS.**

TB 9-6625-2049-35

- (g) **ENTRY FREQ.**
- (h) **100 Hz.**
- (i) **AMPTD CAL.**

(3) Multimeter will indicate between 2.843 and 2.931 V ac.

(4) Enter **1.9 kHz** using **DATA** keys. Multimeter will indicate between 2.843 and 2.931 V ac.

(5) Enter **2.1 kHz** using **DATA** keys. Multimeter will indicate between 2.742 and 3.032 V ac.

(6) Enter **10 kHz** using **DATA** keys. Multimeter will indicate between 2.742 and 3.032 V ac.

(7) Press keys and enter values using **DATA** keys as listed in (a) through (c) below:

- (a) **FUNCTION** positive ramp.
- (b) **100 Hz.**
- (c) **AMPTD CAL.**

(8) Multimeter will indicate between 2.843 and 2.931 V ac.

(9) Enter **499 Hz** using **DATA** keys. Multimeter will indicate between 2.843 and 2.931 V ac.

(10) Enter **501 Hz** using **DATA** keys. Multimeter will indicate between 2.598 and 3.176 V ac.

(11) Enter **10 kHz** using **DATA** keys. Multimeter will indicate between 2.598 and 3.176V ac.

b. Adjustments. No adjustments can be made.

17. Dc Offset

a. Performance Check

(1) Connect TI **SIGNAL** to multimeter **INPUT HI** and **LO** using 50Ω feedthrough termination.

(2) Press **SIGNAL** key off (option 002 not lit).

(3) Press presently active **FUNCTION** key to remove ac output and activate **ENTRY DC OFFSET** key (lit).

(4) Enter **5 VOLT** using **DATA** keys and press **AMPTD CAL** key.

(5) Multimeter will indicate between 4.98 and 5.02 V dc.

(6) Enter **-5 VOLT** using **DATA** keys. Multimeter will indicate between -4.98 and -5.02 V dc.

(7) Repeat technique of (6) above using TI settings and multimeter indications listed in table 5.

Table 5. Dc Offset

Test instrument DC OFFSET settings		Multimeter indications (V dc)	
		Min	Max
1.499	VOLT	1.493	1.505
-1.499	VOLT	-1.505	-1.493
499.9	mV	0.4979	0.5019
-499.9	mV	-0.5019	-0.4979
149.9	mV	0.1493	0.1505
-149.9	mV	-0.1505	-0.1493
49.99	mV	0.04979	0.05019
-49.99	mV	-0.05019	-0.04979

Table 5. Dc Offset - Continued

Test instrument DC OFFSET settings		Multimeter indications (V dc)	
		Min	Max
14.99	mV	0.01493	0.01505
-14.99	mV	-0.01505	-0.01493
4.999	mV	0.004979	0.005019
-4.999	mV	-0.005019	-0.004979
1.499	mV	0.001479	0.001519
-1.499	mV	-0.001519	-0.001479

NOTE

Perform (8) through (11) below for option 002 only.

- (8) Remove 50Ω feedthrough termination from equipment setup.
- (9) Press **SIGNAL** key on.
- (10) Enter **20 VOLT** using **DATA** keys. Multimeter will indicate between 19.775 and 20.225 V dc.
- (11) Enter **-20 VOLT** using **DATA** keys. Multimeter will indicate between -19.775 and -20.225 V dc.

b. Adjustments. No adjustments can be made.

18. Dc Offset with Ac

a. Performance Check

- (1) Connect **SIGNAL** to multimeter **INPUT HI** and **LO** using 50Ω feedthrough termination.
- (2) Press keys and enter values using **DATA** keys as listed in (a) through (i) below:
 - (a) **SIGNAL** off (option 002 not lit).
 - (b) **FUNCTION** sine wave.
 - (c) **ENTRY FREQ.**
 - (d) **20.999 999 999 MHz.**

TB 9-6625-2049-35

- (e) **ENTRY AMPTD.**
 - (f) **1 VOLT.**
 - (g) **ENTRY DC OFFSET.**
 - (h) **4.5 VOLT.**
 - (i) **AMPTD CAL.**
- (3) Multimeter will indicate between 4.35 and 4.65 V dc.
- (4) Enter **-4.5 VOLT** using **DATA** keys. Multimeter will indicate between -4.35 and -4.65 V dc.
- (5) Press **ENTRY FREQ** key and enter **999.9 kHz** using **DATA** keys. Multimeter will indicate between -4.44 and -4.56 V dc.
- (6) Press **ENTRY DC OFFSET** key and enter **4.5 VOLT** using **DATA** keys. Multimeter will indicate between 4.44 and 4.56 V dc.
- (7) Press **FUNCTION** square wave key. Multimeter will indicate between 4.44 and 4.56 V dc.
- (8) Enter **-4.5 VOLT** using **DATA** keys. Multimeter will indicate between -4.44 and -4.56 V dc.
- (9) Press **ENTRY FREQ** key and enter **9.9999 MHz** using **DATA** keys. Multimeter will indicate between -4.35 and -4.65 V dc.
- (10) Press **FUNCTION** triangle key and enter **9.9 kHz** using **DATA** keys.
- (11) Multimeter will indicate between -4.44 and -4.56 V dc.
- (12) Press **FUNCTION** positive ramp key. Multimeter will indicate between -4.38 and -4.62 V dc.

b. Adjustments. No adjustments can be made.

19. High Voltage Output Option 002 only

a. Performance Check

- (1) Connect **SIGNAL** to multimeter **INPUT HI** and **LO**.
- (2) Press keys and enter values using **DATA** keys as listed in (a) through (i) below:
 - (a) **FUNCTION** sine wave.
 - (b) **ENTRY FREQ.**
 - (c) **2 kHz.**
 - (d) **SIGNAL** on.
 - (e) **ENTRY DC OFFSET.**
 - (f) **0 VOLT.**
 - (g) **ENTRY AMPTD.**

(h) **14.14 V RMS.**

(i) **AMPTD CAL.**

(3) Multimeter will indicate between 13.86 and 14.42 V ac.

(4) Press keys and enter values using **DATA** keys as listed in (a) through (e) below:

(a) **ENTRY FREQ.**

(b) **100 kHz.**

(c) **ENTRY AMPTD.**

(d) **10 V RMS.**

(e) **AMPTD CAL.**

(5) Multimeter will indicate between 9 and 11 V ac.

(6) Press keys and enter values using **DATA** keys as listed in (a) through (f) below:

(a) **FUNCTION** square wave.

(b) **ENTRY FREQ.**

(c) **2 kHz.**

(d) **ENTRY AMPTD.**

(e) **20 V RMS.**

(f) **AMPTD CAL.**

(7) Multimeter will indicate between 19.6 and 20.4 V ac.

(8) Press **FUNCTION** triangle key and enter **11.5 V RMS** using **DATA** keys.

(9) Press **AMPTD CAL** key. Multimeter will indicate between 11.27 and 11.73 V ac.

(10) Press **FUNCTION** positive ramp key and repeat (9) above.

b. Adjustments. No adjustments can be made.

20. Power Supply

NOTE

Do not perform power supply check if all other parameters are within tolerance.

a. Performance Check

(1) Connect multimeter **INPUT HI** to -15 V TP (fig. 5) and **LO** to ground side of C9 (fig. 5). Adjust R22 (fig. 5) for a multimeter indication of -14.97 to -15.03 V dc (R).

(2) Connect multimeter **INPUT HI** to +15 V TP (fig. 5). Readjust R22 (fig. 5) if multimeter does not indicate between 14.9 and 15.1 V dc.

(3) Connect multimeter **INPUT HI** to +5 V TP (fig. 5). Readjust R22 (fig. 5) if multimeter does not indicate between 5.01 and 5.05 V dc.

(4) Repeat (1) through (3) above for best in-tolerance condition on all test points.

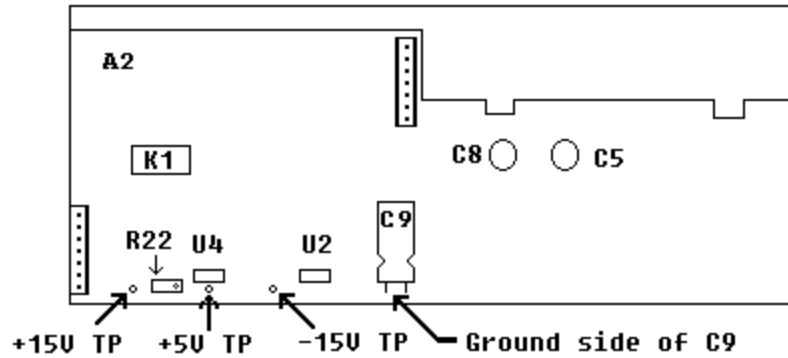

Figure 5. Power supply assembly A2 – test instrument top view.

- (5) Press presently active **FUNCTION** key to remove ac output and activate **ENTRY DC OFFSET** key (lit).
- (6) Enter **0 VOLT** using **DATA** keys and press **AMPTD CAL** key.
- (7) Connect multimeter **INPUT HI** to TP AMP OUT (fig. 3) and **LO** to circuit board ground.

NOTE

The voltages measured in (1) through (3) above may be adjusted out of tolerance by (8) through (11) below. This is not a cause for concern.

- (8) Adjust R40 (fig. 3) until digital multimeter indicates less than 5 mV dc (R).
- (9) Connect multimeter **INPUT HI** and **LO** to TI **SIGNAL**. Do not use 50Ω feedthrough termination.
- (10) Enter **5 VOLT** using **DATA** keys.
- (11) Press **AMPTD CAL** key. Adjust R22 (fig. 5) until multimeter indicates 10.000 V dc.
- (12) Enter **-5 VOLT** using **DATA** keys.
- (13) Multimeter will indicate between -9.985 and -10.015 V dc.

21. Final Procedure

- a. Deenergize and disconnect all equipment.
- b. Annotate and affix DA label/form in accordance with TB 750-25.

TB 9-6625-2049-35

By Order of the Secretary of the Army:

ERIC K. SHINSEKI
General, United States Army
Chief of Staff

OFFICIAL:

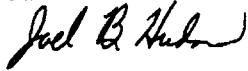

JOEL B. HUDSON
Administrative Assistant to the
Secretary of the Army

0029703

Distribution

To be distributed in accordance with IDN 342200, requirements for calibration procedure TB 9-6625-2049-35.

PIN: 052316-001